



In this issue

Message from the Chair

CHAPTER EVENTS

P.Eng. Licensure and Q/A Session

PEO Oakville Chapter 2021 AGM

Indoor Air Quality – COVID-19 Challenges

Call for Volunteer/Network Night

Education Committee Update

National Engineering Month

Innovation Committee Update

Fireside Chat with Local PEO Councillors

Canada's SMR Roadmap and OPG's New Nuclear Plans

High Rise Construction and Innovation

What is Net Zero Home Design: A Presentation by University of Waterloo Students Design Team

Game Changer for Transitioning Canada to Low-Carbon Economy

Government Liaison Program Update

Upcoming Events

Message from the Chair



Norbert Lee, P.Eng.
Chair, Oakville Chapter
Professional Engineers Ontario
chair@peo-oakvillechapter.ca

Greetings, as we head toward the last months of 2021, I am delighted to report this year can be remembered as a revival year where we witnessed things starting to head back to normal compared to last year.

Our PEO Oakville chapter hosted numerous virtual events throughout the year where we saw record number of attendees in our virtual presentations. Our Government Liaison Program (GLP) connected with local MPPs from Oakville and Milton and was able to continue to network with local MPPs and local businesses as we promoted the importance of licensed engineers in our economy.

We also took the time to welcome 13 new P.Eng.'s who resided within our chapter boundary, and marked this memorable accomplishment with congratulatory notes from local politicians and PEO.

In short, I like to thank our chapter volunteers for continuing the tradition of making PEO Oakville Chapter an engaging and forward thinking chapter within PEO, and look forward to greater things in 2022.

P.Eng. Licensure and Q/A Session January 29, 2021

A very informative webinar was presented (via Zoom) by Tracey Caruana, Manager, Engineering Intern Programs on general guidelines to become a Professional Engineer. The webinar successfully outlined the process required to become licensed engineer in Ontario to over 36 attendees from several chapters and answered their questions.

The PEO Oakville Chapter continues to host the PEO Licensure Assistance Program (LAP) for the 9th round.

The LAP is a program that links engineering interns with professional engineers (guides) licensed with PEO to provide guidance and support as they progress toward obtaining their professional engineering license. In 2021, 15 interns and guides were linked for the LAP program. Due to pandemic the meetings between the guides and interns were held virtually. The program is held annually between May to November.

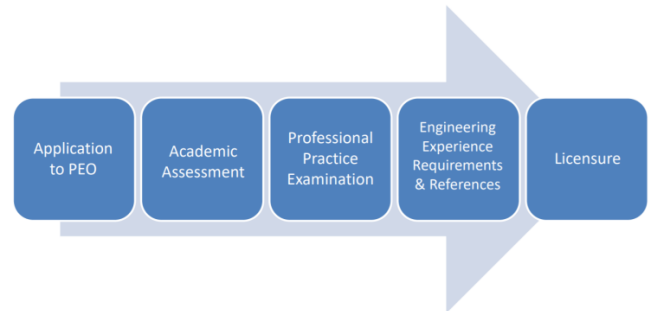

PEO Oakville Chapter 2021 AGM January 27, 2021

The PEO Oakville Chapter Annual General Meeting (AGM) was held on January 27, 2021. Due to the social distancing rules, the meeting was held via Zoom.

During the AGM, chapter activities for 2020 were reviewed and new board members were elected for year of 2021. Congratulation to all the board members!

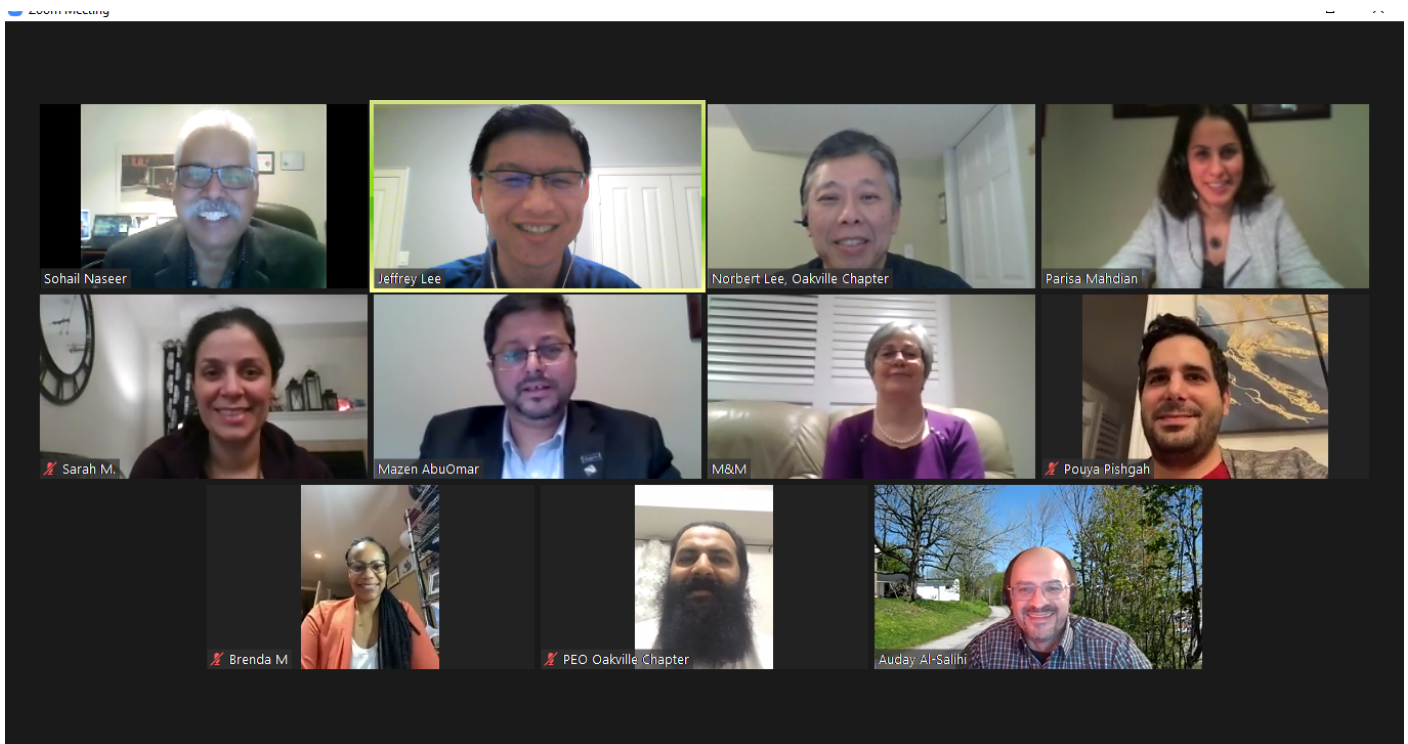

Indoor Air Quality – COVID-19 Challenges February 25, 2021

Mazen Abuomar, Ph.D., P.Eng., P.E., Consulting Engineer is a manager director at Leen Consulting Inc. Mazen provided a technical presentation on air quality and COVID-19 challenges. The indoor air quality is an important aspect of our life. With pandemic in the last year, people start to pay more attention to this subject. There are different products and techniques to improve the indoor air quality in buildings.

The lecture addressed the importance of the indoor air quality standards, systems, products, and techniques. The lecture explored options to enhance Indoor Air Quality and prevent spread of viruses and other germs. 46 people attended this virtual event and based on the questions asked by attendees it was very informative presentations.

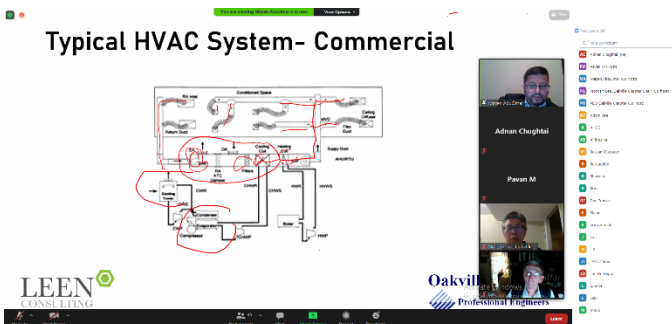
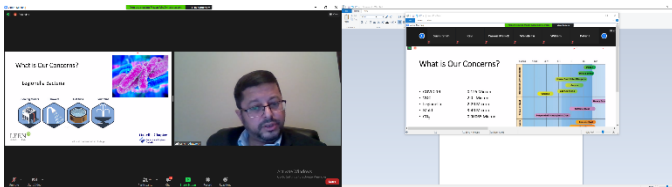

Call for Volunteer/Network Night February 16, 2021

PEO Oakville Chapter had a virtual networking and call for volunteers event. This event was attended by chapter executives, fellow professional engineers and EITs. Information about the functions and programs of the Oakville Chapter were provided to guests who were interested in volunteering. Zoom breakout rooms were established to discuss PEO programs in education, events, GLP and licensing.

Attendees also got a chance to meet the candidates running for PEO's 2021 Council Election and they learned more about their platform and why they should vote for them in the election.

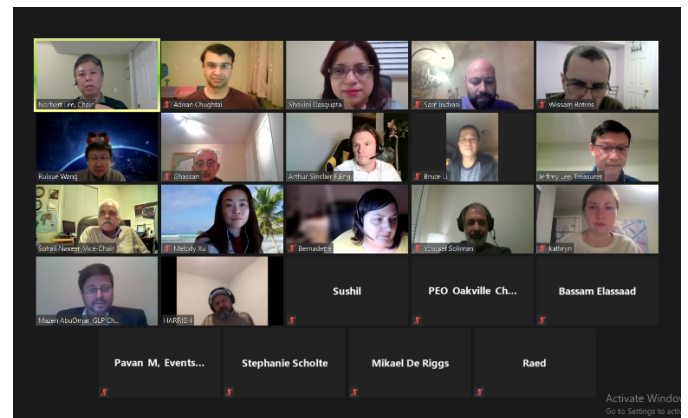

Education Committee Update

National Engineering Month

Each March, the engineering community across Canada celebrates National Engineering Month, Canada's largest celebration of engineering excellence. Created in 1992 by Engineers Canada and the provincial and territorial engineering regulators, National Engineering Month sees the engineering profession spark an interest in the next generation of engineering professionals and to the engineering community to celebrate the role that engineers play in society.

This year's theme was "There's a place for you in engineering!". National Engineering Month celebrated

the diversity of thought, opportunities, and people that make up the engineering profession, and demonstrated that there's a place for everyone in engineering. NEM Ontario supported Chapters to run Zoom events given the pandemic lock downs that did not allow in person meetings.

The Oakville Chapter ran 2 successful events this year in weeks 2 and 3 of National Engineering month. The first session on March 6th, the Chapter held an interactive networking event on how to give and get constructive feedback with university students and PEO members through practicing essential skills and personal reflection. Attendance on zoom reached a peak of 45 during the event. While attendance was lower than previous years, this was a recurring theme for all NEM events as the schedule coincided with provincial lockdowns and students transitioning to remote learning. The second session was on March 18th, and the discussion was geared to allow students on how to choose the right capstone project to get the best value. This session brought value to all participants especially when most in person projects had to be online.

What is an Engineering Capstone Project?

- A project that enables students to synthesize knowledge gained in the (inter)discipline(s) by allowing students to apply what they learned.
- In the past students who were looking for real-world experience had to volunteer, find internships and /or obtain part – time work on their own.
- Now Capstone Projects allow for students to be supported via their education experience to get the real-world experience.

national ENGINEERING MONTH

Agenda
INTERACTIVE – LET'S ALL DISCUSS TOGETHER

- PART 1: Lets get to know each other- Intro
- PART 2: Picking & Managing a Capstone Project (getting engagement, scope creep).[30 mins]
- PART 3: How to give and get constructive feedback - essential skills and personal reflection.[45 mins]

national ENGINEERING MONTH

What is Net Zero Home Design: A Presentation by University of Waterloo Student Design Team

On Aug 18th 2021, The Chapter hosted a Zoom presentation on “What is a Net Zero Home Design” by the University of Waterloo Student Design Team - Dana Usaty, Ankit Shah and Pierre Roy. Attendance for this event peaked to 75 during the presentation with great engagement from the attendees.

WARRIOR HOME

@ info@warriorhome.ca
/company/warrior-home
uw.warrior.home

Pierre Roy - Warrior Home
Ankit Shah - Warrior Home
Dana Usaty - Warrior Home
Branda M

Warrior Home is a student-led design team at the University of Waterloo, centered around designing and constructing affordable, net-zero energy homes in partnership with community housing organizations. They focus on innovation, education and community impact in the sustainable building industry to create world-class engineers of the future. In this presentation, the presenters walked through some of the team's recent award-winning projects, submitted into the U.S. Department of Energy's Solar Decathlon Competition,

while talking about the many innovative engineering and architectural considerations implemented in these designs.

Members of the Warrior Home team stand in front of the home they helped design and build on the Neyaashiinigiing (Warrior Home):



Where We Are in the Filtering (and What's Next)

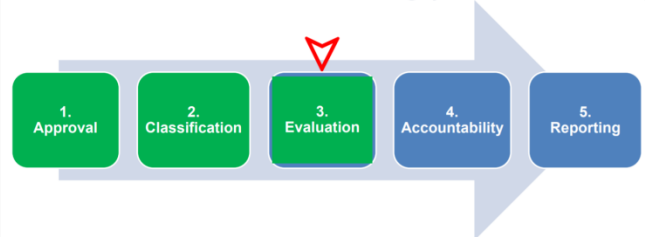

Innovation Committee Update

2021 has been a challenging year for everyone which has forced us to rethink the way in which we do a lot of things. One of these has been in person meetings and events. The Oakville chapter was able to tackle those challenges by adopting Zoom to hold it's monthly EB meetings in addition to various online events such as virtual Certificate Ceremony. Look forward to more announcements on virtual events in 2022.

Fireside Chat with Local PEO Councillors May 3, 2021

PEO is continuing its path of improved governance, modernized regulation and adopting operational changes. Significant transformation is taking place at all levels of PEO.

Oakville Chapter hosted our local PEO officials and Councillors – Darla Campbell, Lisa MacCumber and Warren Turnbull, to share and update us of these important activities taking place.

Governance Roadmap Work Plan: The 4 Phases



Canada's SMR Roadmap and OPG's New Nuclear Plans May 27, 2021

David Tyndall, P. Eng., Director New Build Engineering, Ontario Power Generation (OPG), gave us a lecture about Canada's Small Modular Reactor (SMR) Roadmap and OPG's Nuclear Plans.

Given aggressive climate change goals, Canada recognized the need for a diverse set of energy production methods and a vital role for nuclear to fulfil. This helped form the basis for Canada's SMR Roadmap, followed by the SMR Action Plan in 2020. OPG has a significant leadership role in making New Nuclear a reality. The presentation covered the background of the roadmap, and OPG's new nuclear plans.

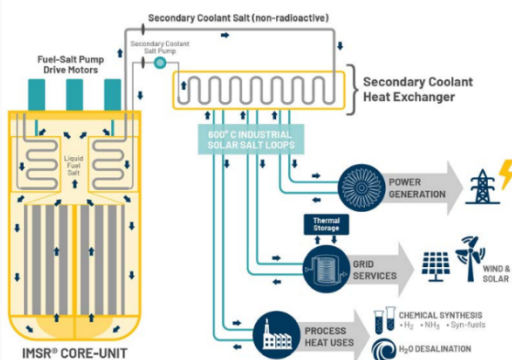
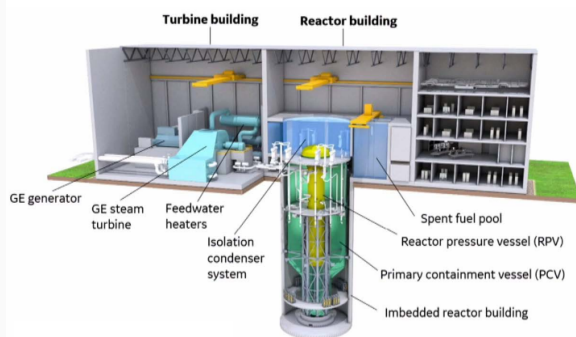

High Rise Construction and Innovation June 17, 2021

Jason Yee and Sahand Shafikiya from Mattamy Homes provided an informative presentation about High Rise Construction and Innovation on June 17, 2021. A total of 72 people attended this virtual presentation.

As demand for high rise residential construction continues to increase, there are ever growing opportunities for engineers to help shape the future of the Golden Horseshoe region. This presentation seeks to provide an overview of the high rise construction process, as well as the role of the various engineering disciplines involved. The presentation provided a review of recent engineering innovations, as well as a discussion on the opportunities for innovation of the various factors that continue to challenge the industry.



Game Changer for Transitioning Canada to Low-Carbon Economy September 21, 2021

Cody MacNeil, P.Eng and Scott Matthews from NRStor Inc. gave us a lecture about game changer for transitioning Canada to low carbon economy.

Representing the largest project of its kind in Canada, the proposed half billion dollar Oneida Energy Storage project includes development of a 250 megawatt / 1000 megawatt-hour energy storage facility in Southwestern Ontario. It is a joint venture between NRStor Inc. and Six Nations of the Grand River Development Corporation.

The Oneida Energy Storage project will provide clean, reliable power capacity by drawing and storing existing surplus baseload and renewable energy during off peak periods and releasing it to the Ontario grid when energy demand is at its peak while optimizing the use of existing assets, reducing inefficiency and waste. In addition, it will help stabilize Ontario's electricity sector by providing important grid balancing services and reducing renewable curtailment

The facility is expected to provide significant benefits to Ontario's ratepayers by reducing the need and cost associated with using gas-fired power plants during times of peak demand.

Energy storage facility will help to enable Canada's transition to a low-carbon economy and make Ontario a global leader in cleantech innovation. The project will help Ontario reduce greenhouse gas emissions by 4.1 million tonnes, or the equivalent of taking 40,000 cars off the road every year.

Construction is anticipated to begin in fall 2021. When operational, Oneida Energy Storage will be the largest in Canada and amongst the largest battery energy storage facilities in the world.

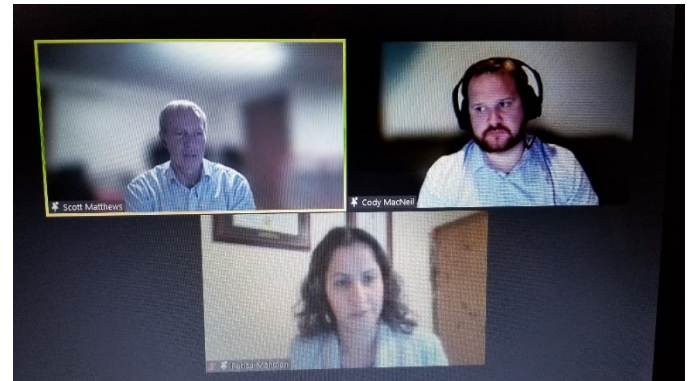

Grid-Scale Energy Storage and the Oneida Battery Project



PEO – Oakville Chapter



Oneida will provide 250 MW / 1,000 MWh of flexible, dynamic capacity to the Ontario grid as it undergoes its refurbishment and retirement cycle



Oneida allows for more efficient operations of Ontario's gas plant fleet, resulting in a reduction of 4.1 MM tonnes of CO₂ emissions over 20 years



Oneida reduces SBG by 30 – 90 GWh / year



Ratepayer savings of \$760 MM expected by providing long-duration flexibility

Government Liaison Program Update

Take your MPP to Work

PEO Oakville Chapter hosted a Take Your MPP To Work Day with Stephen Crawford, MPP (Oakville), Parliamentary Assistant to the Minister of Energy. This was our first Virtual take your MPP Event with PEO. The event took place on Wednesday September 8, 2021, and it was hosted by IPEX in Oakville.

IPEX, headquartered in Oakville, ON., is leader in thermoplastic piping systems that are used in different applications. IPEX companies design and manufacture the largest, most recognized and diverse range of integrated piping products. IPEX has two plants in Ontario (Toronto and Mississauga), in addition to plant in Alberta and several plants in USA.

Oakville Chapter GLP chair gave introductory remarks to the event and highlighted importance of Engineers for the public. Chapter Chair talked about the role of chapter and the importance of PEO in regulating the engineering profession.

MPP Crawford and Mr Sobot, from IPEX, discussed the role provincial government can play to expand the plant production capacity and R&D efforts by IPEX. MPP Crawford was impressed with the IPEX product line and their role in improving Ontario economy. Mr. Sobot expressed IPEX appreciation for the support from Ontario Government to support Ontario manufacturing business and products.

MPP Crawford has been a regular participant in PEO Oakville Chapter activities since his election in June 2018. Take Your MPP To Work Days are helpful opportunities to build relationships with MPPs and let them know about PEO's role as the regulator of the profession in the public interest. He spoke highly of the program and the important work that PEO and engineers do.

In the photo are (first row from left to right) **Stephen Crawford**, MPP (Oakville), IPEX VP corporate Affairs, **Veso Sobot**, P.Eng, Chapter GLP Chair **Mazen AbuOmar**, P.Eng., (second row from left to right) Chapter Chair, **Norbert Lee**, P.Eng, Chapter Treasurer and GLC Vice Chair, **Jeffery Lee**, P.Eng, Chapter GLP Coordinator, **Jarvis Lu**, P.Eng., (third row left to right) Chapter GLP Coordinator **Bruce Li**, P.Eng, Assistant to MPP Crawford, **John Ferko** and PEO GLP Consultant **Howard Brown**

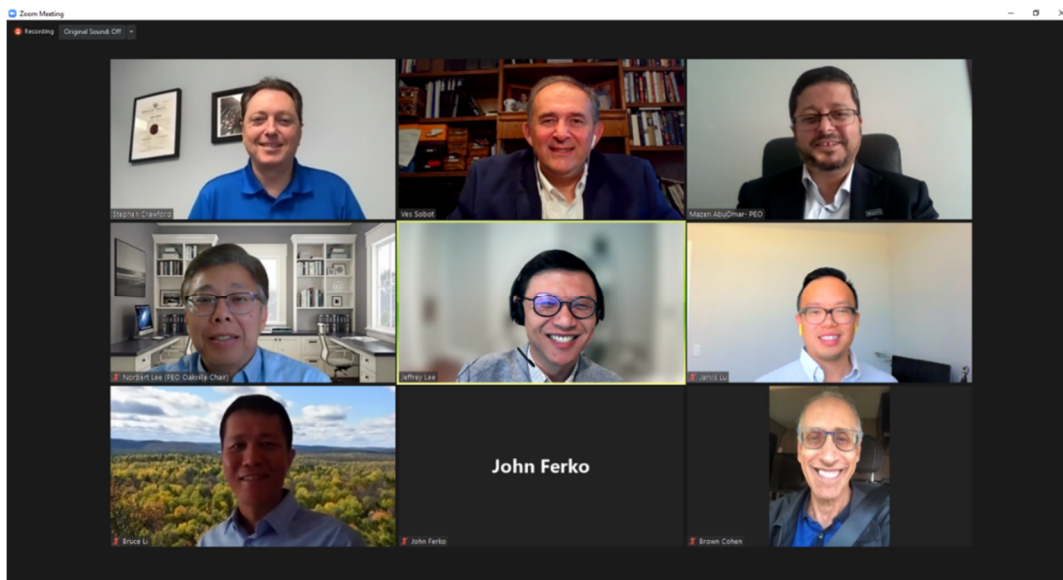

Meeting with Minister of Long Term care Rod Philips and MPP Effie Triantafilopoulos (Oakville)

PEO Oakville Chapter attended an event organized by MPP Effie Triantafilopoulos on Wednesday October 13, 2021.

MPP Triantafilopoulos hosted Minister of Long Term Care Rod Phillips in Oakville. The minister announced the construction of new Long term facility in Oakville.

PEO Oakville Chapter GLP Chair Mazen AbuOmar, PEng, attended the event. Dr. AbuOmar participated in the discussion with MPP Triantafilopoulos about the long term facilities and the role of engineers in improving indoor air quality and providing the most healthy environment to the health care facilities.

MPP Triantafilopoulos thanked PEO Oakville chapter for their participation in the event and all other events organized by the MPP.



Left to right, Rod Philips Minister of Long Term Care, Mazen AbuOmar, PEng, PEO Oakville Chapter-GLP Chair, Effie Triantafilopoulos, MPP Oakville North – Burlington



Effie Triantafilopoulos, MPP Oakville North, Burlington Mazen AbuOmar, PEng, PEO Oakville Chapter-GLP Chair

Virtual meeting with Oakville MPP Stephen Crawford

Oakville Chapter GLP Committee arranged a virtual meeting with Oakville MPP Stephen Crawford on Tuesday Aug. 10, 2021.

The meeting was attended by Jeffery Lee P.Eng (Oakville Chapter treasurer and PEO GLC member), Jeannette Chau P.Eng (PEO, Manager, Government Liaison Programs), Howard Cohen (PEO, GLP Consultant), Bruce Li (PEO GLP Representative in Oakville North & Burlington and member of Oakville chapter), Melody Xu P.Eng (PEO GLP Representative in Oakville riding and member of Oakville chapter) and Dr. Mazen AbuOmar P.Eng (Oakville Chapter GLP Chair).

After a warm round-table self-introduction, the meeting started with MPP Crawford's updates of his new role of Assistant Minister of Energy, and some of the key initiatives and works in his office, including connecting festival grand with visit Oakville to support Tastes of Oakville and the preparation of this year's Christmas events on Kerr St. . MPP Crawford expressed his goodwill on Ontario's economic recovery, re-iterated his support for development but also his determination to protect our environment.

MPP Crawford discussed with attendees PEO interest to enhance the connection with government and Ontario legislature

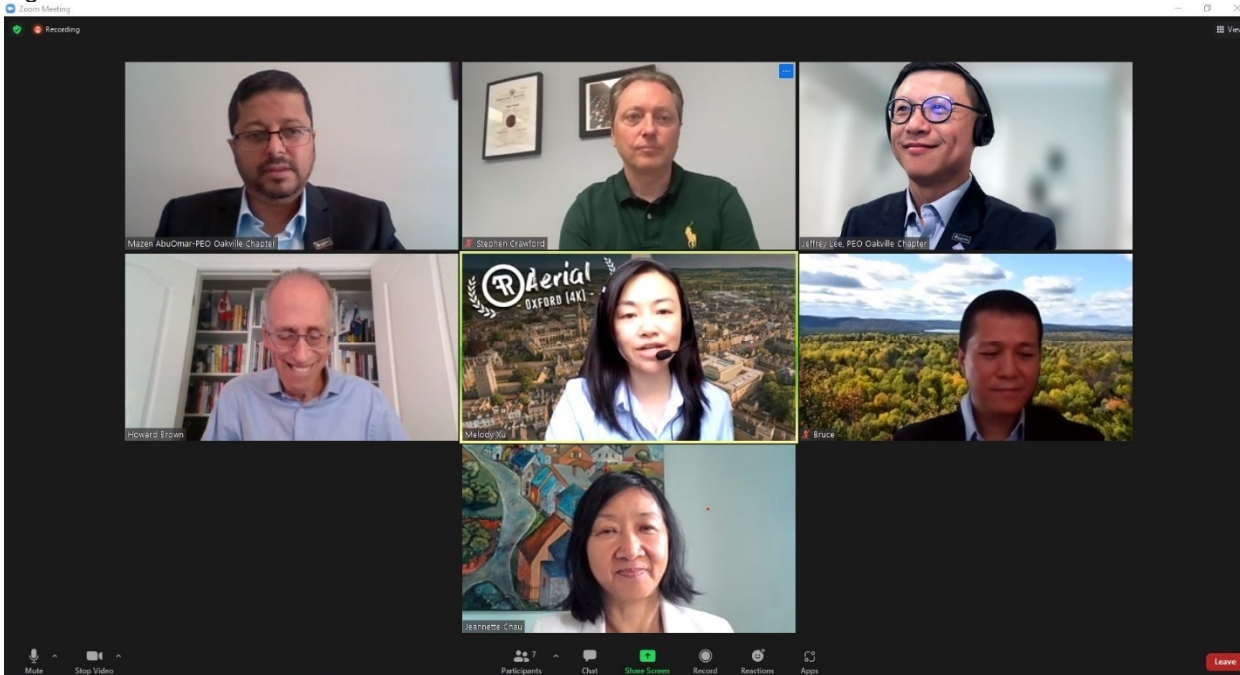

Virtual Certificate Presentation Ceremony 2021

On October 27, 2021, the Oakville chapter held our annual fall certificate and award presentation ceremony. Similar to last year, the event was presented virtually due to Covid-19 breakout. The event was well attended and 13 new P.Eng. recipients received their certificates in a virtual certificate presentation ceremony. The following politicians participated in the certificate ceremony:

- Parm Gill, MPP, Milton- recoded video
- Stephen Crawford, MPP, Oakville (attended virtually)
- Effie Triantafilopoulos, MPP Oakville North- Burlington (recorded video)

Norbert Lee, P. Eng., Chair of PEO Oakville Chapter, gave a very inspiring presentation about future engineers.

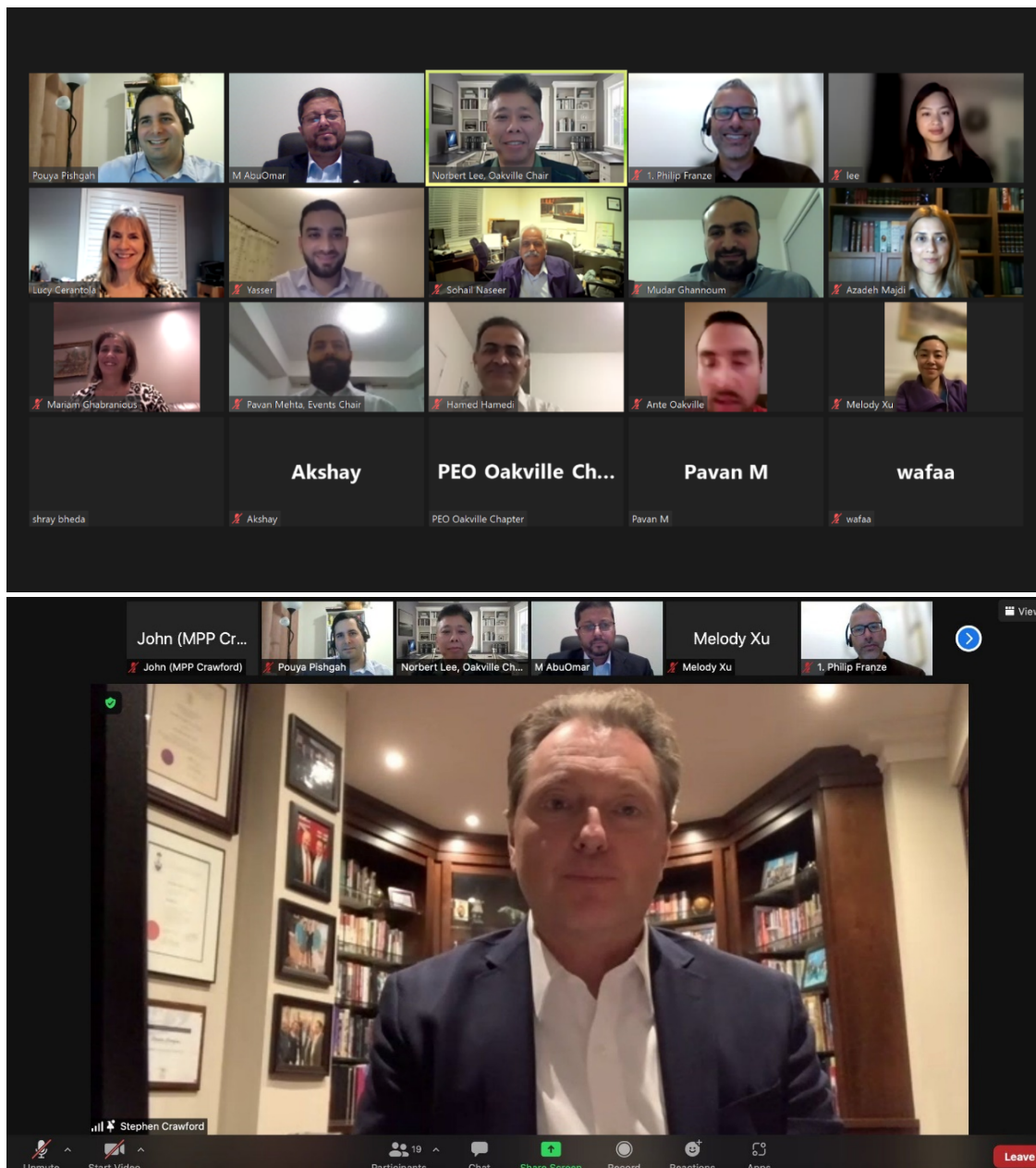

November 30, 2021

Electrification Event with Oakville Chamber of Commerce



PEO Oakville Chapter with Oakville Chamber of Commerce will have a panel discussion about electrification on November 30, 2021. Representatives from OPG, Ford and WSP will attend the panel discussion virtually through ZOOM meeting.

Additional registration details will be provided soon.

February 3, 2022

Oakville Chapter Annual General Meeting



Professional Engineers
Ontario

Oakville Chapter

PEO Oakville Chapter Annual General Meeting (AGM) will be held on February 3, 2022.

All members are requested to register and attend the event. The annual report will be presented for chapter activities and a new executive board will be elected for 2022.

Additional registration details will be provided in early January 2021. For more information please contact Sohail Naseer vice-chair@peo-oakvillechapter.ca

Call for Volunteers and Speakers



Volunteering with PEO Oakville Chapter is a great opportunity to network with other engineers and develop friendships while collaborating on various activities that enhance engineering industry and community. We have a variety of opportunities and volunteering positions available in 2022. We are always looking out for speaker events as well, if you have something that may be of interest to other engineers, please contact us. For more information about volunteering opportunities and speaker events, please contact Norbert Lee chair@peo-oakvillechapter.ca

2021 Executive Board Officers and Members

Officers

Chair

Norbert Lee

chair@peo-oakvillechapter.ca

Vice Chair

Sohail Naseer

vice-chair@peo-oakvillechapter.ca

Secretary & Privacy Officer

Sarah Majlesi

secretary@peo-oakvillechapter.ca

Treasurer

Jeffrey Lee

treasurer@peo-oakvillechapter.ca

Past Chair

Parisa Mahdian

past-chair@peo-oakvillechapter.ca

Committee Chairs

Education Committee Chair

Brenda Vimbai Munyukwi

education@peo-oakvillechapter.ca

Events Committee Chair

Pavan Mehta

events@peo-oakvillechapter.ca

GLP Committee Chair

Mazen Abuomar

glp-chair@peo-oakvillechapter.ca

Coordinators

Certificate Presentation

Coordinator

Pouya Pishgah

certificates@peo-oakvillechapter.ca

GLP Co Chair (s) and Coordinators:

Sohail Naseer

glp-advisor@peo-oakvillechapter.ca

Jeffrey Lee

glp@peo-oakvillechapter.ca

Melody Xu

Bruce Li

Jarvis Lu

Innovation Coordinator

Pavan Mehta

innovation@peo-oakvillechapter.ca

LAP Director

Auday Al-Salihi

lapd@peo-oakvillechapter.ca

Web and Media Coordinator

Parisa Mahdian

media@peo-oakvillechapter.ca

Newsletter Editor

Pouya Pishgah

newsletter@peo-oakvillechapter.ca

Webmaster

Mehri Mansouri

webmaster@peo-oakvillechapter.ca

Volunteer at Large

Rainer Arocena

Adnan Chughtai

Len D'Elia

Quoc-Viet Le-The

Adrian Pierorazio

Abu Zahid